

TBV-C



**Combined control & balancing
valves for small terminal units**
For ON-OFF control

Engineering
GREAT Solutions

TBV-C

Designed for use in terminal units in heating and cooling systems, the TBV-C ensures accurate hydronic control and optimum throughput over a long lifetime. IMI Hydronic Engineering's dezincification resistant alloy, AMETAL®, minimises the risk of leakage.

Key features

- > **Presetting tool**
For accurate and easy balancing.
- > **Self-sealing measuring points**
For quick and easy measurement.
- > **Shut-off function**
Ensures straightforward maintenance procedures.



Technical description

Application:

Heating and cooling systems.

Functions:

Control
Balancing
Pre-setting
Measuring
Shut-off (for isolation during system maintenance)

Dimensions:

DN 15-25

Pressure class:

PN 16

Temperature:

Max. working temperature: 120°C

Min. working temperature: -20°C

Leakage rate:

Tight sealing

Material:

Valve body: AMETAL®
Seat seal: Valve disc of EPDM (DN 15-20). EPDM/AMETAL® (DN 25).
Spindle seal: EPDM O-ring
Valve insert: AMETAL®, PPS (polyphenylsulphide)
Return spring: Stainless steel
Spindle: Nedox® coated AMETAL®
Smooth ends:
Nipple: AMETAL®

AMETAL® is the dezincification resistant alloy of IMI Hydronic Engineering.

Marking:

Body: TA, PN 16/150, DN, inch size and flow direction arrow.

Identification ring on measuring point:
White = Low flow (LF)
Black = Normal flow (NF)

Actuators:

See separate information on EMO T.

Sizing

When Δp and the design flow are known, use the formula to calculate the Kv-value.

$$Kv = 0,01 \frac{q}{\sqrt{\Delta p}} \quad q \text{ l/h, } \Delta p \text{ kPa}$$

$$Kv = 36 \frac{q}{\sqrt{\Delta p}} \quad q \text{ l/s, } \Delta p \text{ kPa}$$

Setting

TBV-C is delivered with a red protective cap, Article No 52 143-100, which must be used when isolating the valve.

TBV-C is delivered with the pre-setting fully open. The setting of a valve for a given pressure drop, e.g. corresponding to position 5 is done as follows:

1. Place the presetting tool, Article No 52 133-100, at the valve.
2. Turn the presetting tool so that position 5 is pointing at the index* of the valve body.
3. Remove the presetting tool. The valve is now set.

There is a diagram for every valve size that shows the flow for different pressure drops and settings.

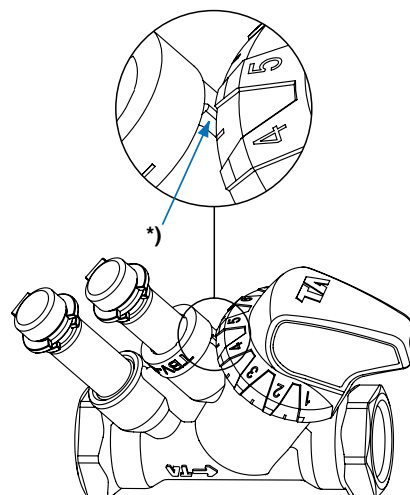

Noise

The following conditions must be fulfilled in order to avoid noise in the heating system:

- Flows correctly balanced
- The water in the system must have been de-aerated
- Circulation pumps which do not generate excessive differential pressures (alternatively use a differential pressure controller, e.g. STAP)

The maximum recommended pressure drop in order to avoid noise is 30 kPa = 0,3 bar.

Measuring accuracy

Flow deviation at different settings



*) Position

Try to avoid mounting taps and pumps, immediately before the valve.

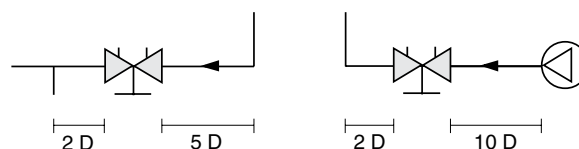

Installation

Application example

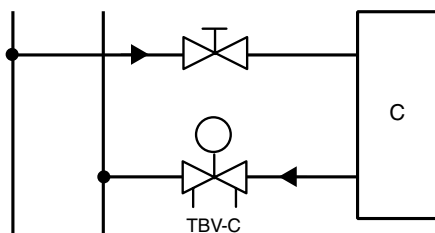

Flow direction

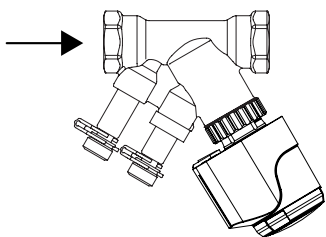

Installation of actuator EMO T

Approx. 15 mm of free space is required above the actuator.

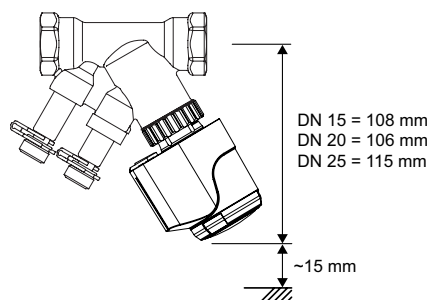

TBV-C + EMO T

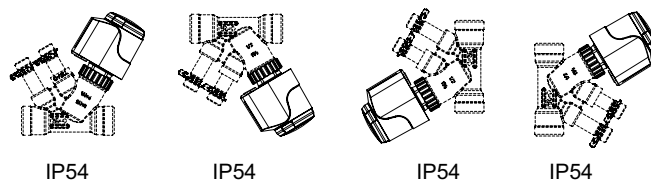

Closing force

Necessary force (F) to close the valve versus the differential pressure (Δp).

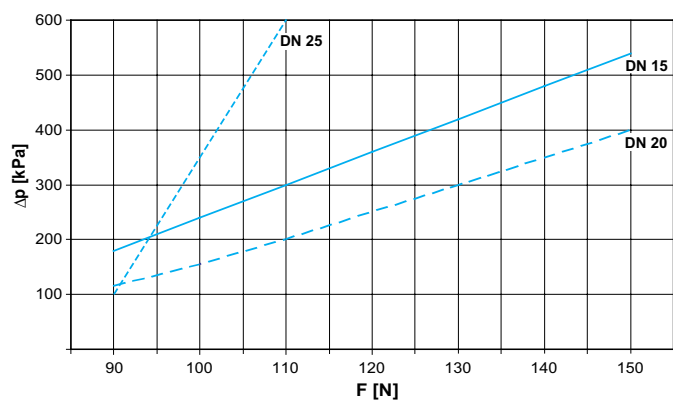
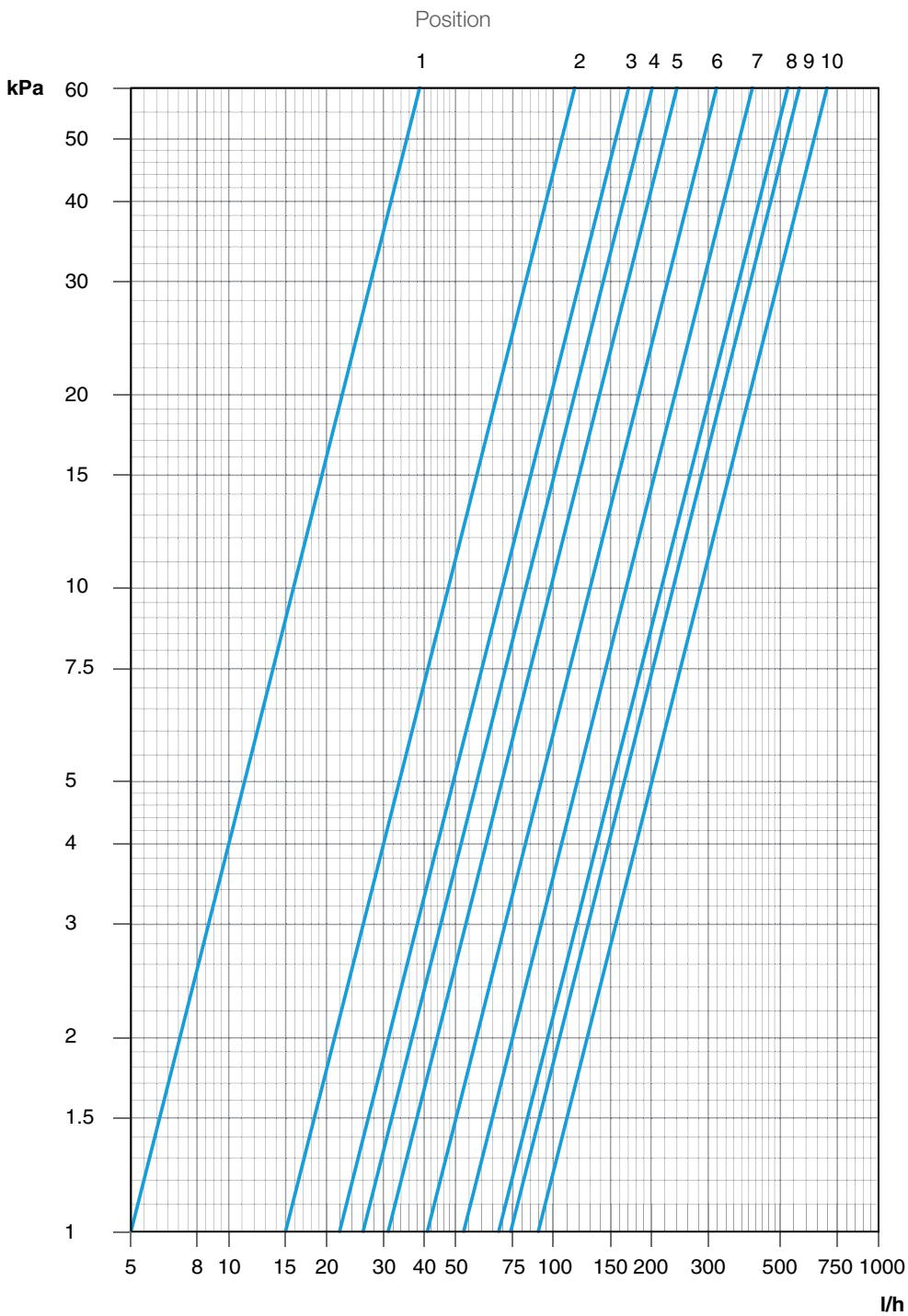

Diagram TBV-C LF, DN 15



Position	1	2	3	4	5	6	7	8	9	10
Kv	0,05	0,15	0,22	0,26	0,31	0,41	0,53	0,68	0,74	0,90

Recommended setting: Position 3-10

Diagram TBV-C NF, DN 15

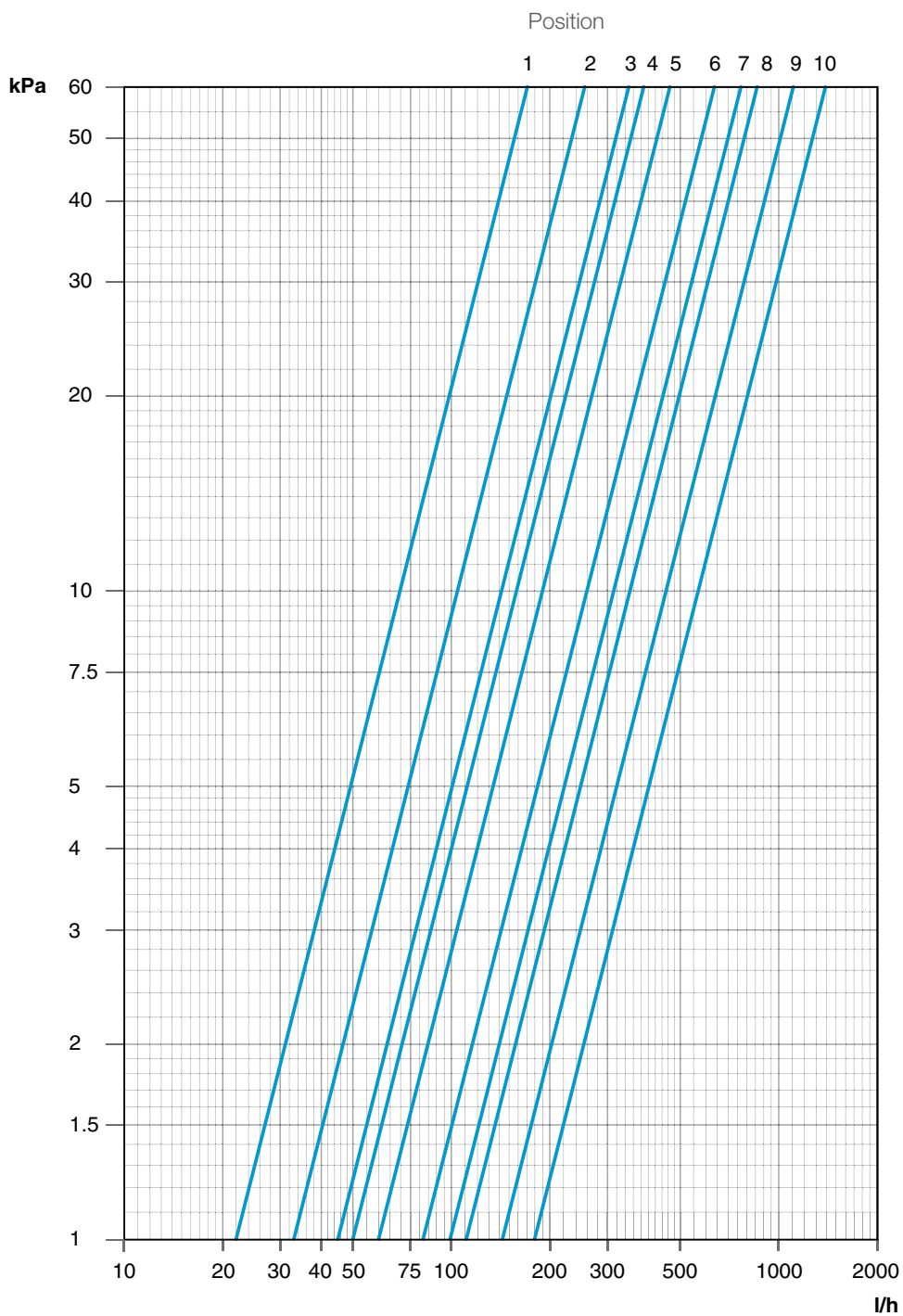

Position	1	2	3	4	5	6	7	8	9	10
Kv	0,22	0,33	0,45	0,50	0,60	0,82	0,99	1,1	1,4	1,8

Recommended setting: Position 3-10

Diagram TBV-C NF, DN 20

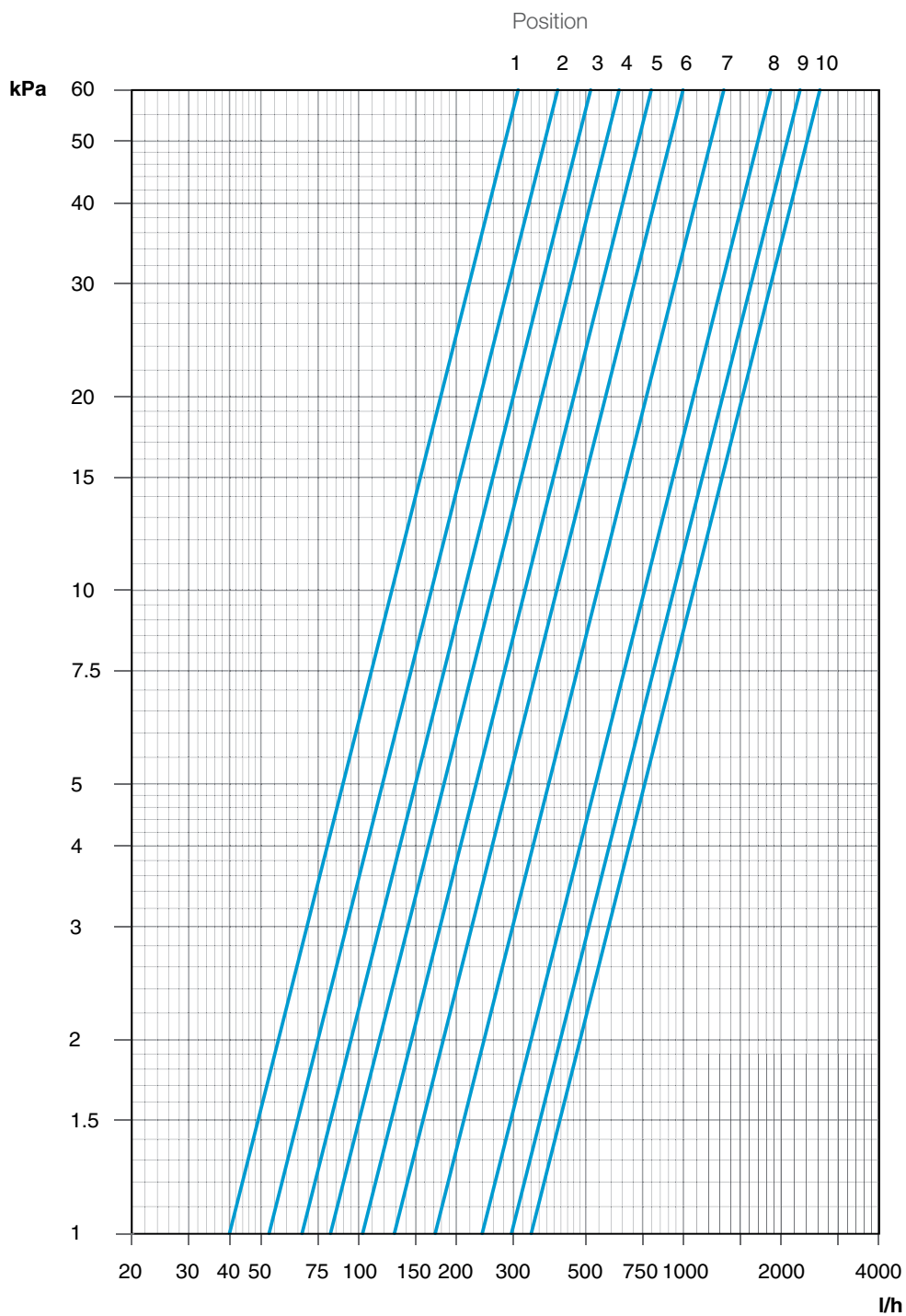

Position	1	2	3	4	5	6	7	8	9	10
Kv	0,40	0,53	0,67	0,82	1,0	1,3	1,7	2,4	3,0	3,4

Recommended setting: Position 3-10

Diagram TBV-C NF, DN 25

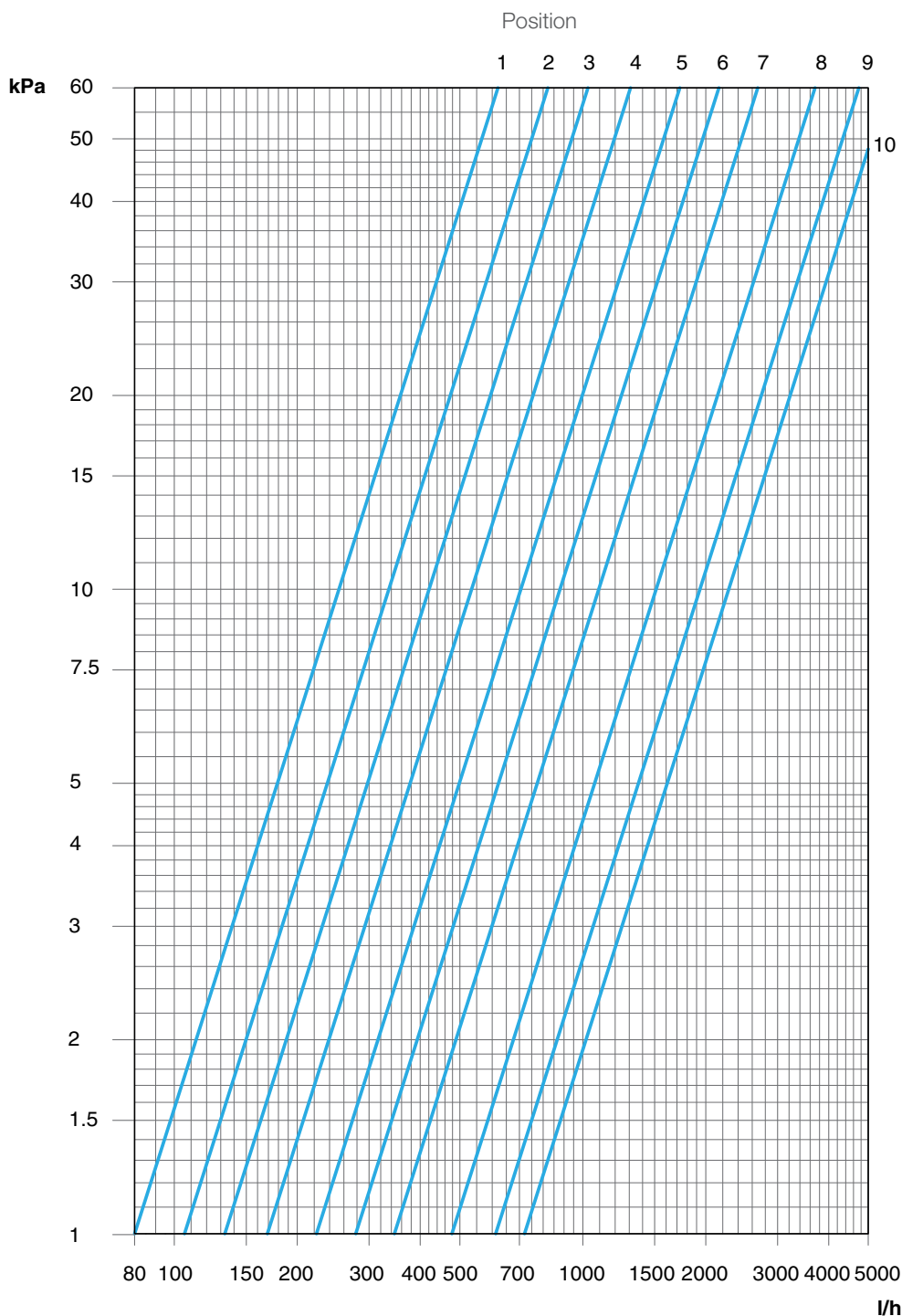

Position	1	2	3	4	5	6	7	8	9	10
Kv	0,80	1,0	1,3	1,7	2,2	2,8	3,5	4,8	6,1	7,2

Recommended setting: Position 3-10

Articles

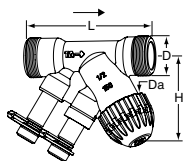

Male thread

DN	D	Da*	L	H	Kvs	Kg	EAN	Article No
TBV-C LF, low flow								
15	G3/4	M30x1,5	85	58	0,90	0,35	7318793870506	52 133-015
TBV-C NF, normal flow								
15	G3/4	M30x1,5	85	58	1,8	0,35	7318793870803	52 134-015
20	G1	M30x1,5	96	57	3,4	0,40	7318793870902	52 134-020

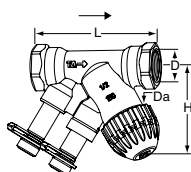

Female thread

DN	D	Da*	L	H	Kvs	Kg	EAN	Article No
TBV-C LF, low flow								
15	G1/2**	M30x1,5	81	58	0,90	0,34	7318793859204	52 133-115
15	Rc1/2	M30x1,5	81	58	0,90	0,34	7318793991102	52 133-615
TBV-C NF, normal flow								
15	G1/2**	M30x1,5	81	58	1,8	0,34	7318793871008	52 134-115
20	G3/4**	M30x1,5	91	57	3,4	0,40	7318793871107	52 134-120
25	G1	M30x1,5	111	64	7,2	0,73	7318793966100	52 134-125
15	Rc1/2	M30x1,5	81	58	1,8	0,34	7318793991201	52 134-615
20	Rc3/4	M30x1,5	91	57	3,4	0,40	7318793991300	52 134-620
25	Rc1	M30x1,5	111	64	7,2	0,73	7318793991409	52 134-625

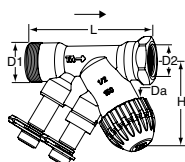

Male thread with eurocone x Female thread

DN	D1	D2	Da*	L	H	Kvs	Kg	EAN	Article No
TBV-C LF, low flow									
15	G3/4	G1/2**	M30x1,5	85	58	0,90	0,36	7318793870605	52 133-215
TBV-C NF, normal flow									
15	G3/4	G1/2**	M30x1,5	85	58	1,8	0,35	7318793871206	52 134-215

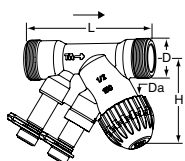

Male thread with eurocone

DN	D	Da*	L	H	Kvs	Kg	EAN	Article No
TBV-C LF, low flow								
15	G3/4	M30x1,5	84	58	0,90	0,35	7318793870704	52 133-315
TBV-C NF, normal flow								
15	G3/4	M30x1,5	84	58	1,8	0,34	7318793871305	52 134-315

*) Connection to actuator.

**) Can be connected to smooth pipes by KOMBI compression coupling. See catalogue leaflet KOMBI.

G = Thread according to ISO 228. Thread length according to ISO 7/1.

Rc = Thread according to ISO 7 (\approx BS 21).

Kvs = m^3/h at a pressure drop of 1 bar and fully open valve.

\rightarrow = Flow direction

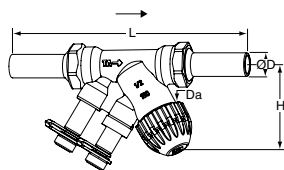
Smooth ends

DN	D	Da*	L	H	Kvs	Kg	EAN	Article No
TBV-C LF, low flow								
15	15	M30x1,5	145	58	0,90	0,44	7318793935700	52 433-115
TBV-C NF, normal flow								
15	15	M30x1,5	145	58	1,8	0,44	7318793935908	52 434-115
20	22	M30x1,5	173	57	3,4	0,57	7318793936103	52 434-120

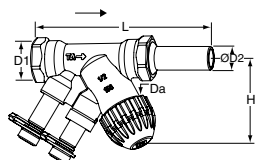
Female thread x Smooth end

DN	D1	D2	Da*	L	H	Kvs	Kg	EAN	Article No
TBV-C LF, low flow									
15	G1/2**	15	M30x1,5	113	58	0,90	0,39	7318793935809	52 435-115
TBV-C NF, normal flow									
15	G1/2**	15	M30x1,5	113	58	1,8	0,39	7318793936004	52 436-115
20	G3/4**	22	M30x1,5	132	57	3,4	0,48	7318793936202	52 436-120

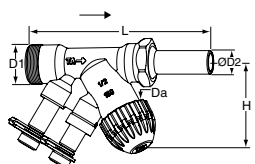
Male thread with eurocone x Smooth end

DN	D1	D2	Da*	L	H	Kvs	Kg	EAN	Article No
TBV-C LF, low flow									
15	G3/4	15	M30x1,5	117	58	0,90	0,40	7318793936301	52 433-215
TBV-C NF, normal flow									
15	G3/4	15	M30x1,5	117	58	1,8	0,40	7318793936400	52 434-215

*) Connection to actuator.

**) Can be connected to smooth pipes by KOMBI compression coupling. See catalogue leaflet KOMBI.

G = Thread according to ISO 228. Thread length according to ISO 7/1.

Kvs = m³/h at a pressure drop of 1 bar and fully open valve.

→ = Flow direction

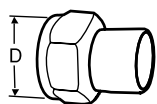
Connections for male thread

Welding connection

Swivelling nut
Max 120°C

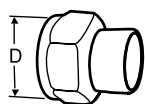
Valve DN	D	Ø Pipe	EAN	Article No
15	G3/4	15	7318792748509	52 009-015
20	G1	20	7318792748608	52 009-020

Soldering connection

Swivelling nut
Max 120°C

Valve DN	D	Ø Pipe	EAN	Article No
15	G3/4	15	7318792749308	52 009-515
15	G3/4	16	7318792749407	52 009-516
20	G1	18	7318792749506	52 009-518
20	G1	22	7318792749605	52 009-522

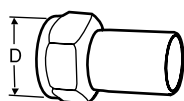
Connection with smooth end

For connection with press coupling
Swivelling nut
max 120°C

Valve DN	D	Ø Pipe	EAN	Article No
15	G3/4	15	7318793810601	52 009-315
20	G1	18	7318793810700	52 009-318
20	G1	22	7318793810809	52 009-322

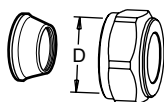

Compression connection

max 100°C

Support bushes shall be used, for more information see catalogue leaflet FPL.

Valve DN	D	Ø Pipe	EAN	Article No
15	G3/4	15	7318793705006	53 319-615
15	G3/4	18	7318793705105	53 319-618
15	G3/4	22	7318793705204	53 319-622
20	G1	28	7318793705402	53 319-928

Connections for male thread with eurocone

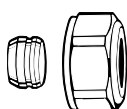

Compression fitting for copper or steel pipes

For eurocone

Metal-to-metal sealing

Support bushes shall be used.

Ø Pipe	EAN	Article No
12	4024052214211	3831-12.351
15	4024052214617	3831-15.351
16	4024052214914	3831-16.351
18	4024052215218	3831-18.351

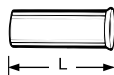

Support sleeve

for copper or precision steel pipe with a 1 mm wall thickness.

Brass.

Ø Pipe	L	EAN	Article No
12	25,0	4024052127016	1300-12.170
15	26,0	4024052127917	1300-15.170
16	26,3	4024052128419	1300-16.170
18	26,8	4024052128815	1300-18.170

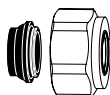

Compression fitting for copper or steel pipes

For eurocone

Nickel plated, soft sealing (EPDM)

Ø Pipe	EAN	Article No
15	4024052515851	1313-15.351
18	4024052516056	1313-18.351



Compression fitting for plastic pipes

For eurocone

Ø Pipe	EAN	Article No
14x2	4024052134618	1311-14.351
16x2	4024052134816	1311-16.351
17x2	4024052134915	1311-17.351
18x2	4024052135110	1311-18.351
20x2	4024052135318	1311-20.351



Compression fitting for multi-layer pipes

For eurocone

Ø Pipe	EAN	Article No
16x2	4024052137312	1331-16.351

Accessories

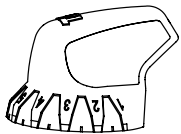

Presetting tool

For TBV-C, TBV-CM, TBV-CMP,
KTCM 512

EAN

Article No

7318793886002

52 133-100

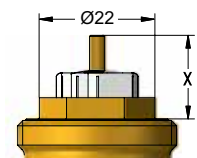

Actuator EMO T

For more details of EMO T, see separate catalogue leaflet.

TBV-C is developed to work together with the EMO T actuator. Actuators of other brands require a working range of:

X (closed - fully open) = 11,4 - 15,1 (DN 15-20) / 11,4 - 15,8 (DN 25)

IMI Hydronic Engineering will not be held responsible for the control function if actuators other brand than IMI TA are used.